

See discussions, stats, and author profiles for this publication at: <https://www.researchgate.net/publication/282538746>

Feasibility analysis of a standalone direct pumping photovoltaic system for irrigation in Mediterranean greenhouses

Article in *Renewable Energy* · January 2016

DOI: 10.1016/j.renene.2015.07.056

CITATIONS

19

READS

84

4 authors, including:



Juan Reca

Universidad de Almería

47 PUBLICATIONS **692** CITATIONS

[SEE PROFILE](#)



Rafael López-Luque

University of Cordoba (Spain)

62 PUBLICATIONS **939** CITATIONS

[SEE PROFILE](#)



Juan Martínez

Universidad de Almería

18 PUBLICATIONS **358** CITATIONS

[SEE PROFILE](#)

Some of the authors of this publication are also working on these related projects:



Efecto de la intensidad y calidad de la iluminación en la horticultura respetuosa con el medio ambiente y la salud humana [View project](#)

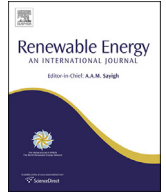

Feasibility analysis of a standalone direct pumping photovoltaic system for irrigation in Mediterranean greenhouses



J. Reça^{a,*}, C. Torrente^a, R. López-Luque^b, J. Martínez^a

^a Department of Engineering, University of Almería, La Cañada de S. Urbano S.N. 04120, Almería, Spain

^b Department of Applied Physics, University of Córdoba, Room C21E030, Albert Einstein Building, Campus of Rabanales, 14071, Córdoba, Spain

ARTICLE INFO

Article history:

Received 3 February 2015

Received in revised form

17 July 2015

Accepted 21 July 2015

Available online xxx

Keywords:

Photovoltaic system

Irrigation

Drip

Greenhouse

ABSTRACT

The profitability of photovoltaic (PV) systems for irrigating Mediterranean greenhouse crops is analyzed. A standalone direct pumping PV system is proposed. A simulation model of the system was developed in order to obtain the economically optimal design of this system and evaluate its feasibility. The model is composed of several submodels: the photovoltaic power generation capacity submodel, the direct pumping management submodel and the submodel that evaluates the irrigation water requirements for a representative greenhouse and the overall economic performance of the system.

The effect of the total number of irrigation sectors per hectare on the performance of the system has been analyzed. Two management strategies have been considered: to irrigate with only one irrigation sector simultaneously or to irrigate with a variable number of irrigation sectors as a function of the incoming power provided by the PV array. The optimal operation strategy provided by the model was the first one as the second was penalized by the higher cost of the pumps. The system becomes profitable for at least 4 sectors per hectare. The profitability and energy use efficiency of this type of systems are relatively low, although these values could be improved if the excess of energy were used for other purposes, such as ventilating or cooling the greenhouse.

© 2015 The Authors. Published by Elsevier Ltd. This is an open access article under the CC BY-NC-ND license (<http://creativecommons.org/licenses/by-nc-nd/4.0/>).

1. Introduction and objectives

Solar energy has a very high potential in Mediterranean areas, as its climate is characterized by a high number of sunlight hours. For this reason, the irrigation of many crops in these areas with photovoltaic energy systems is increasingly gaining interest.

Greenhouse vegetable production is one of the most important economic activities in many regions of the Mediterranean basin [11,34], as is the case in the province of Almería in Southern Spain. The province of Almería has a greenhouse area of 27,000 ha [37], which represents approximately 60% of the total greenhouse area in the whole country. The economic returns obtained from vegetable production have contributed to the development and welfare of the region. For this reason, the sustainability of the greenhouse vegetable production sector is of vital importance to its economy.

The energy consumption in the protected greenhouse horticulture in Almería is equivalent to 14% the total energy

consumption in the whole province. In the greenhouse irrigation districts, the electricity distribution networks and facilities are fifty times denser than in other rural areas. However, in many countries in the Mediterranean basin like Spain, the price of the electricity has become increasingly higher in recent years. For example, the price of the electricity for households has doubled in the last decade, rising from a price of 0.0885 €/kWh in 2004 to a price of 0.1752 €/kWh in 2013 [18]. The increase in the energy costs can jeopardize the economical feasibility of most of these greenhouse farms and photovoltaic energy is thus an increasingly interesting alternative.

One of the main technical limitations that must be faced when using photovoltaic systems in greenhouses is the lack of space to lay the photovoltaic system. The price of land in greenhouse irrigation area is high and all the surface area is occupied with greenhouses, reservoirs, warehouses and irrigation facilities. However, the development of the photovoltaic energy generation technology offers different alternatives to cope with this problem nowadays. Solar radiation, especially during summer time can be very high, in Mediterranean areas. For this reasons, different techniques like the use of screens and coating applications, are used to moderate the

* Corresponding author.

E-mail addresses: jreca@ual.es (J. Reça), fa1lolur@uco.es (R. López-Luque), jumartin@ual.es (J. Martínez).

intensity of radiation in greenhouses [29]. Different research works have proposed mounting the photovoltaic cells on the greenhouse roof. This fact implies that the excessive sunlight irradiating greenhouses could be useful to provide an electrical energy source using photovoltaic (PV) modules.

Several research works performed to analyze the effect of partial shading on crop yield [5,12,26,27] have pointed out that moderate partial shading does not have a significant effect on crop yield reduction. Kitta et al. [25] recommended a shading factor no higher than 20% for sweet pepper in Mediterranean climate conditions.

Different types of materials and technical solutions have been proposed to integrate the solar based energy generation systems into greenhouses, from conventional opaque flat hard or planar flexible PV modules with different type of arrangements (straight-line and checkerboard) to semitransparent PV modules [23,35,38,39,42,45,46].

More recently, progress in PV cell technologies has provided new possibilities for solar cell applications. Biancardo et al. [9] developed a semitransparent PV module composed of spherical solar microcells characterized by its small size and its isotropic ability for photoreception. Yano et al. [47] tested the performance of this new type of PV System on a greenhouse. These studies showed that although conscientious design is necessary, it is possible to generate enough electricity for the control of greenhouse environment appliances using PV systems that are compatible with plant cultivation [23,39,42].

A few years ago, in some countries like Spain, the existence of favourable feed-in tariffs for renewable energy sources made more sense economically to sell the produced energy to the energy distribution company rather than to consume it on the farm itself. However, this situation has changed nowadays as this feed-in tariff has been considerably cut-off. In addition, storing the energy in batteries implies a high cost and environmental impact. Solar energy can be consumed on-farm for different purposes [1], like to power ventilation systems [48] or to heat the greenhouse [31,32]. In Mediterranean climate greenhouses, however, the energy consumption for ventilation or heating is negligible as most of the greenhouses have passive ventilation systems and do not have heating systems. For this reason, in this work, the feasibility of using the generated energy to irrigate the greenhouse crops is going to be analyzed as irrigation is the most energy-demanding operation in the above mentioned conditions.

PV systems have been successfully applied to irrigate different types of crops in different climates and cropping conditions [2,13,33,44]. The most widely spread type of stand-alone photovoltaic irrigation systems is one that is designed to pump water from wells or reservoirs to an elevated storage reservoir. Water is then distributed to the plants by gravity [21,22,30]. However, farms in greenhouse irrigation districts in southern Spain are usually flat, so water stored in farmers' individual storage reservoirs does not have enough energy and it need to be pumped in order to reach the pressure required by the emitters. For this reason, a direct PV pumping system is thus required.

Another problem that must be faced is that irrigation application times are relatively short in greenhouse cropping while the production of energy is distributed during sunlight hours, so there is a gap between offer and demand. One possibility to cope with this gap could be to establish a net metering billing policy. Net metering is a billing mechanism that credits solar energy system owners for the electricity they do not use and add to the grid. The system owners can consume the energy they have in their accounts whenever they need within the applicable billing period. Although some countries have issued regulations regarding net metering billing policies, in other countries, like Spain, these regulations have not been implemented yet.

To overcome the above-mentioned drawbacks, a stand-alone direct pumping photovoltaic irrigation system to irrigate greenhouse crops is proposed in this work. The total irrigation time is going to be extended with the aim of taking advantage of the solar energy received by considering several irrigation sectors per hectare. In addition, the proposed system will include variable speed pumps and non-compensating emitters. With this combination, the discharge of the irrigation system can be varied in order to adjust the power consumed by the irrigation system to the power produced by the PV array.

In order to optimize the design and management of the proposed system and to analyze its technical and economic feasibility, a simulation model has been developed. This simulation model requires the calculation of the irrigation water requirements for a representative greenhouse farm in the area.

The model is composed of several submodels: the photovoltaic power generation capacity submodel, the direct pumping management submodel and the submodel that evaluates the irrigation water requirements for a representative greenhouse.

The model simulates increasing values of peak power of the photovoltaic system. For each of these values, it calculates the water and energy balance in the photovoltaic irrigation system, the investments and operational costs of the system and finally the economic feasibility of the system. The model enables us to select the optimal design of the system which achieves maximum economic profitability.

2. Methodology

2.1. General description of the photovoltaic irrigation system

In this work a direct pumping PV irrigation system is proposed [28]. The system is composed of a photovoltaic array that provides electricity for driving the variable speed pumps. Water is going to be applied to the crops through non-compensating emitters which have the ability to vary their discharge depending on their working pressure. In this way, the flow of water pumped by the system is a function of the speed of the pump and the speed of the pump is related to the electrical power generated by the photovoltaic system.

In addition, in order to improve the balance between the power generated by the PV system and the power requirements of the irrigation systems, the optimal size of the irrigation subunit and the possibility of operating more than one irrigation subunit simultaneously as a function of the incoming power is going to be analyzed in this work.

Two different scenarios are thus going to be evaluated:

- a) To irrigate with only one irrigation sector in operation
- b) To irrigate with multiple irrigation sectors in operation simultaneously

In the first scenario, only one pump is required as the same pump would be used to irrigate all the irrigation sectors. In the second scenario, the number of pumps would have to be equal to the number of sectors that irrigate simultaneously.

Fig. 1 illustrates a diagram of the system with a total of 6 irrigation sectors and a variable number of pumps.

A computer program has been developed to simulate the irrigation performance of this PV irrigation system. The program is based on mathematical models of each component of the PV pumping system: the PV array, the pumping and the crop sub-systems. These mathematical models are going to be described hereafter.

2.2. Characterization of the representative greenhouse irrigation system and calculation of the water demands for irrigation

Greenhouse farms are heterogeneous and their energy requirements for irrigation, heating ventilation and other purposes are variable. A greenhouse in central Europe has many differences with respect to one in the Mediterranean basin. Our research has been focused on the greenhouse farms located in the coastal area of Almería in the Southeast of Spain. This area is characterized by mild winter temperatures (18 °C annual average temperature) and high solar radiation (from 3000 to 3600 sunlight hours per year), which cause high evaporation and evapotranspiration levels. The area also features low annual and irregularly distributed rainfalls (concentrated in spring and autumn).

Due to the actual differences among greenhouse farms, a first step to analyze the feasibility of applying the PV energy in the greenhouse farms is to characterize a standard representative greenhouse farm. The characterization of the representative greenhouse farm topology has been obtained from the information provided by different studies and surveys performed in the area [15,36,43].

Greenhouse farms in this area are relatively small in size as most of them are family enterprises. The average greenhouse farm area is approximately 1.9 ha and it is composed of two greenhouses with an area of 0.75 ha/greenhouse on average.

The most common type of greenhouse is the so-called “Almería type” greenhouse (95% of the total area). It is built with a light structure and covered with a plastic film and they can be classified into low and medium technology greenhouses according to Pardossi et al. [34].

Most of the greenhouses have only passive ventilation systems (92.5%) and windows are mainly controlled manually, so there are not any energy requirements to ventilate the greenhouse in most cases.

Mediterranean greenhouses in this area do not usually have heating systems contrary to the greenhouses in central Europe. A study performed about the production of tomato in different types of greenhouses and countries, highlighted that while in a glass Venlo type greenhouse in The Netherlands the percentage of energy used for heating the greenhouse was 31% of the total energy consumed, in an Almería type greenhouse in Spain this energy requirements were zero [41]. However, some of the most technologically advanced greenhouses in Almería use cooling systems

Table 1
Physical properties of the soil.

Variable	Value
Effective crop rooting depth, <i>RD</i>	0.4 m
Field capacity	0.18 m/m
Permanent wilting point	0.1 m/m
Available soil moisture	0.08 m/m
Allowable depletion factor	0.3
Initial depletion	0 mm
Maximum allowed depletion	9.6 mm
Total water depletion	32 mm

during summer periods (20%). Ultimately, the major energy consumption in Mediterranean greenhouses comes from crop irrigation.

The crops are mainly grown on soil (almost 86%). The typical soil in this area (almost 80% of the total surface) is an artificial layered soil called ‘enarenado’, which utilizes a thin layer of sand on the top [19]. Substrate culture is practiced on the rest of the farms (14%). Table 1 shows the main physical properties of the soil used in this work. These values have been obtained from the laboratory analyses of several soil samples in the area.

Drip irrigation is the main irrigation method used in greenhouses due to its agronomic and water saving advantages. Farmers usually have water ponds or tanks in order to guarantee water availability. From there, the water is pumped into the on-farm irrigation distribution system. The typical system head consists of a pump, water filters, fertilizer injectors and control devices. The irrigation water is distributed to the emitter by a branched distribution network made of polyethylene pipes. The irrigation subunits are composed of one manifold with laterals fed from one end. There is one lateral for every crop row.

The values taken in this work are those more common in irrigation systems in this area. The separation of the laterals is 1 m approximately. The emitters are usually integrated inline drippers with a discharge of 3 L h⁻¹ and are separated at a distance of 0.5 m. The resulting total discharge per hectare is thus 60000 L h⁻¹ (16.67 L s⁻¹). The average pumping head has been estimated equal to 40 m and the calculated power needed results in 8720 W per ha.

The irrigation water requirements depend on the crop type and cycle. The irrigation water requirements are going to be calculated for the average cropping pattern in the area with the aim of evaluating a representative average greenhouse.

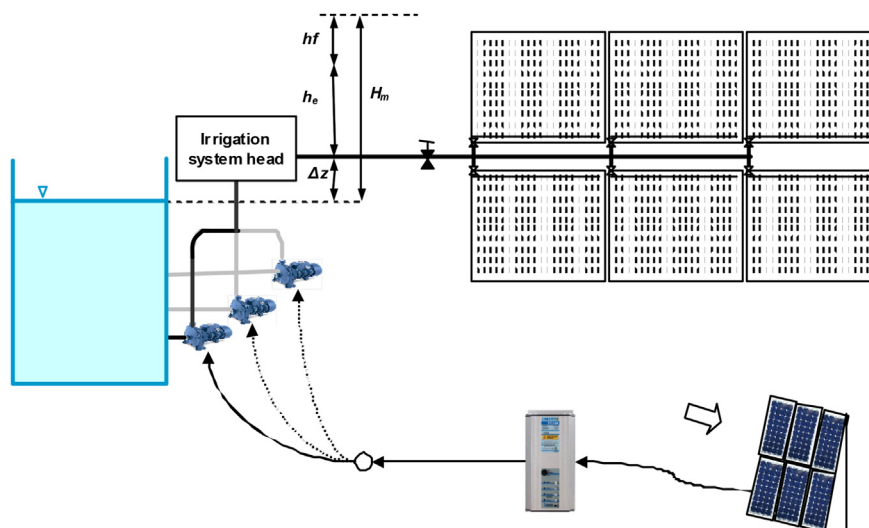

Fig. 1. Diagram of the PV irrigation system with a total of six irrigation sectors.

The crop distribution has been calculated using the statistics provided by the Government of Andalusia for the agricultural year 2012–13. The most extended crops in a decreasing order are: tomato, pepper, courgette, watermelon, cucumber, melon and aubergine. Table 2 shows the crop distribution for the seven main crops. The percentages of the area of every crop with respect to the total cultivated area and with respect to the total greenhouse area have also been calculated. Note that the percentage of the total crop area over the total greenhouse area is greater than 100 as many greenhouses have two crop cycles per year.

The irrigation requirements for a typical greenhouse were estimated as the weighted average of the irrigation requirements of every crop. In this work, the weekly irrigation requirements for the every crop cultivated under Almería type greenhouse recommended by the “Las Palmerillas” Agricultural Research Station have been used.

$$IR_w = \sum_{c=1}^{n_c} IR_{w,c} \cdot \frac{CA_c}{GA} \quad (1)$$

where:

- IR_w = Average water needs (mm day⁻¹) in week w
- $IR_{w,c}$ = Water needs for crop c (mm day⁻¹) in week w .
- CA_c = Area of the crop c (ha).
- GA = Total greenhouse area (ha).
- n_c = Total number of crops

2.3. PV array subsystem

Pumping systems based on solar PV have rapidly developed over the last decade, mainly due to the progressive lowering of the cost of the PV modules and the development of new electronic solutions for power conditioning [10].

In this paper the system configuration proposed by Alonso Abella et al. [3] has been adopted. This system configuration is characterized by the use of centrifugal pumps driven by 3-phase asynchronous motors with generic frequency inverters. Most of these inverters possess input/output electronic control modules that allow optimizing the energy use efficiency by using the appropriate feedback control loop [7].

Fig. 2 shows a block diagram of the system components.

The net photovoltaic power provided by the PV generator (P_{PV}) can be described by Equation (2).

$$P_{PV} = \begin{cases} \frac{I(t)}{I_{STC}} PP [1 - \beta(T_{cell} - T_{STC})] & \text{if } I(t) > I_m \\ 0 & \text{if } I(t) < I_m \end{cases} \quad (2)$$

Table 2

Area, yield and percentages of every crop with respect to the total cultivated area and with respect to the total greenhouse area.

Crop	Area (ha)	Yield (Tons)	TCA/TA (%)	TCA/GA (%)
Tomato	10,358	962,663	24.20	36.25
Pepper	8461	541,870	19.77	29.61
Courgette	6448	374,674	15.07	22.56
Watermelon	6400	359,191	14.96	22.40
Cucumber	4920	411,189	11.50	17.22
Melon	4200	134,652	9.81	14.70
Aubergine	2006	145,972	4.69	7.02
Total	42,793	2,930,211	100.00	149.75

TCA/TA = Total crop area/total area.

TCA/GA = Total crop area/greenhouse area.

Where: $I(t)$ is the irradiance on the inclined collector plane expressed in $W m^{-2}$, I_{STC} is the irradiance under standard conditions ($1000 W m^{-2}$), PP is the peak power generated by the PV modules (in W) under standard conditions, β is the performance decay coefficient due to the rising temperature of the cell. For silicon cells, it is set to $0.004 ^\circ C^{-1}$, T_{cell} is the temperature of the cells in the module and T_{STC} is the cell temperature under standard test conditions ($25 ^\circ C$). Equation (1) considers that the output power vanishes as the irradiance gets lower than a threshold limit (I_m). In fact, this is an indirect way to take into account the existence of a lower limit for output power to produce discharge. I_m value will depend on the frequency inverter as well as on the PV peak power. Betka and Attali [6] proposed I_m values around $250 W m^{-2}$ while Amer and Younes [4] estimated around $500 W m^{-2}$ for their facilities values. The value of I_m should be lower for higher PP values as the final power threshold can be achieved with less irradiance. The approach adopted in this work considers that I_m depends on the PP value of the installation and satisfies Equation (3) and, consequently Equation (4).

$$\frac{I_m}{I_{STC}} PP [1 - \beta(T_{cell} - T_{STC})] = P_{PV,min} \quad (3)$$

$$I_m = \frac{P_{PV,min}}{PP} \frac{I_{STC}}{[1 - \beta(T_{cell} - T_{STC})]} \quad (4)$$

where: $P_{PV,min}$ is the minimum value of utilizable photovoltaic power. Its value will be presented further in relation to the minimum useful power.

T_{cell} depends on a parameter called Nominal Operating Cell Temperature (NOCT). If NOCT value is not known, $48 ^\circ C$ is recommended as a reasonable value which describes well most of the commonly used PV modules [14,3]. Under this consideration T_{cell} can be estimated by using the following equation:

$$T_{cell} = T_a + S \cdot I(t) \quad (5)$$

where: T_a is the air temperature and S is a slope coefficient whose value is $0.03 ^\circ C/(W m^{-2})$ for silicon cells.

In this work, the irradiance, $I(t)$, is estimated as a function of time by means of Equation (6). It comes from a general model, which is valid for any tilt angle ($0 < \varphi < \pi/2$), and considers an isotropic distribution of the diffuse radiation [17].

$$I(t) = \frac{\cos \theta}{\cos \theta_z} I_b(t) + \frac{1 + \cos \varphi}{2} I_d(t) + \rho \frac{1 - \cos \varphi}{2} [I_b(t) + I_d(t)] \quad (6)$$

where: θ is the direct solar radiation incidence angle with respect to the inclined collector plane, θ_z is the direct solar radiation incidence angle with respect to the horizontal plane, $I_b(t)$ is the solar direct irradiance as a function of time t ($W m^{-2}$), $I_d(t)$ is the solar diffuse irradiance as a function of time t ($W m^{-2}$), φ is the tilt angle of the PV modules and ρ is the albedo

Direct and diffuse irradiance values are obtained by the model proposed by Collares-Pereira and Rabl [16] from the values of the global daily radiation expressed in $MJ m^{-2}$.

The net power that is finally transferred to the water (P) is given by the following equation:

$$P = \eta_P \cdot \eta_{AM} \cdot \eta_{FC} \cdot P_{PV} \quad (7)$$

Where: η_{FC} is the efficiency of the converter. This value is higher than 0.95 for most of the commercial converters. A constant value of 0.95 has been thus chosen as a conservative criterion, η_{AM} is the

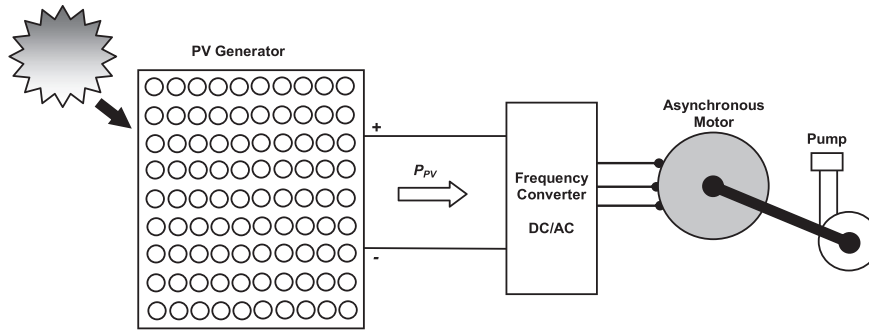

Fig. 2. Layout of the PV system.

efficiency of the asynchronous motor. This efficiency gets higher as the frequency of the electrical current diminishes. A constant value of 0.8 has been used as a conservative criterion, η_p is the pump efficiency. For a variable speed pump, efficiency remains relatively constant for different operating points, provided that similarity conditions are maintained. A constant pump efficiency value of 0.75 has been used in this work.

It is assumed that the PV system is located in the middle of the “Campo de Dalías” area at 36° 44′ 34″ North latitude and 2° 44′ 06″ Western longitude. The inclination of the PV cells is 50° in order to increase autumn and winter power production, its azimuth is 0° and its albedo is 0.2.

2.4. Stand-alone PV pumping subsystem

The irrigation distribution system is composed of a pumping system that boosts water directly into the irrigation distribution network.

With the aim of determining the operating point of the pumping system (pump head and discharge) as a function of the generated power of the PV system, a simplified but widely generic representation of the water distribution network will be used to describe the system curve. The total head (H) required by the distribution system to supply a discharge Q can be decomposed into the following components:

$$H = \Delta z + hf + h \quad (8)$$

where: Δz is a constant value that represents the elevation change from the reservoir to the greenhouse irrigation network (m), hf are the overall head losses in the distribution system (m) and h is the average pressure head of the emitters of the system (m).

This simplified scheme is a good approximation to reality as the size of the greenhouses is relatively small and they are usually laid on a flat and horizontal terrain.

Head losses in this simplified system scheme will be calculated by using a general head loss equation as a function of the pump discharge [8]. Assuming that the flow regime is turbulent, it can be supposed that the hydraulic exponent of this head loss equation is equal to 2 (Equation (9)).

$$hf = R_s \cdot Q^2 \quad (9)$$

where: R_s is the equivalent resistance coefficient of the irrigation system (that includes both uniformly distributed losses in pipes and local head losses) and Q is the total discharge of the pumping system.

The discharge in a non-compensating emitter varies as a function of its working pressure. The relationship between these two variables is given by its discharge equation [24].

$$q = kh^x \quad (10)$$

Where: k is the emitter discharge coefficient, which is a constant dependent on the unit system used. h is the emitter pressure head (m), x is the pressure discharge exponent of the emitter (non-dimensional) and q is the discharge of the emitter (l/h). Conventional labyrinth type emitters usually work in a turbulent regime, so the value of their exponent is close to 0.5. In the simplified irrigation scheme proposed in this work, an average h value will be considered and the hydraulic variability in the irrigation unit will be neglected.

Total discharge in the pumping system can be approximated by the sum of the discharge of all the emitters in the distribution system (n_e).

$$Q = q \cdot n_e = n_e \cdot k \cdot h^x \quad (11)$$

From the previous Equations (10) and (11), the average pressure at the emitters can be derived from the total discharge of the system using Equation (12).

$$h = \left(\frac{1}{n_e k} \right)^2 Q^2 = K \cdot Q^2 \quad (12)$$

And substituting Equations (9) and (12) into Equation (8) results in Equation (13).

$$H = \Delta z + (R_s + K) \cdot Q^2 \quad (13)$$

From Equation (13), the following relationship between the head and discharge provided by the pump can be obtained for the maximum pump speed (N) and for any other pump speed.

$$\frac{H_i}{H_M} = \frac{\Delta z + (R_s + K) \cdot Q_i^2}{\Delta z + (R_s + K) \cdot Q_M^2} \quad (14)$$

where: H_M and Q_M are the maximum head and discharge; respectively, of the system with the pump working at its maximum speed, and H_i and Q_i are the homologous working point for any other speed of the pump.

Assuming that the constant term Δz is relatively low in comparison with the two terms that are dependent on the discharge, the relationship in Equation (14) can be simplified to:

$$\frac{H_i}{H_M} \approx \frac{Q_i^2}{Q_M^2} \quad (15)$$

Equation (15) demonstrates that the operating point of the pumping system for varying pumping speeds follows approximately the “equal efficiency curve” η_p obtained from the application of the pump affinity laws. Nevertheless, global efficiency

involves taking into account all the system efficiencies as expressed in Equation (7). By applying the affinity laws, the following relationship between power and discharge can be obtained:

$$Q_i = Q_M \left(\frac{P_i}{P_M} \right)^{1/3} \quad (16)$$

where: Q_i is the discharge for a specific pump speed (i) and P_i is the power of the pump for the same pump speed.

Assuming that the values of the head (H_M) and discharge (Q_M) for maximum pump speed are known per hectare of greenhouse farm (design values), Equation (16) allows calculating the discharge of the pumping system (Q_i) for an incoming power provided by the PV system equal to P_i .

The error made in the estimation of the discharge due to the previous assumption depends on the elevation change, the pump characteristics and the pump speed. The higher the elevation change and the lower the pump speed are, the higher the error in the discharge estimation is going to be. A preliminary estimation of this error was performed as a function of the ratio of the elevation change to the total pumping head ($\Delta z/H_M$) for a specific pump commonly used in greenhouse irrigation systems. This estimation was made by comparing the resulting discharges and pump efficiencies both considering the affinity laws and without considering them. If the value of ($\Delta z/H_M$) is zero, both errors are zero as the resistance curve of the system matches an affinity iso-efficiency curve (constant η_p). However, as ($\Delta z/H_M$) values increase the operating point falls farther away from the iso-efficiency curve. This separation is higher for low N_i/N_M values. For instance, for a value of this ratio equal to 0.05 ($\Delta z = 5\% H_M$), the relative error in the discharge estimation is equal to 2% and for a $\Delta z/H_M$ equal to 0.1 ($\Delta z = 10\% H_M$), the relative error increases to 4.45%. Regarding, the pump efficiency, the average error ranges from 0.64% for a $\Delta z/H_M$ value equal to 0.05–1.14% for a $\Delta z/H_M$ value equal to 0.1. These results demonstrate that the assumption adopted in this work is acceptable as the errors made in the discharge and pump efficiency values can be neglected provided that the $\Delta z/H_M$ values are below 0.1.

The speed of the pump as a function of the discharge can be expressed by the following equation:

$$N_i = N_M \left(\frac{Q_i}{Q_M} \right) \quad (17)$$

The relative pump speed (N_i/N_M) should be restricted to a minimum as a function of the allowable working range of the emitters. Let r_h be the ratio of the minimum working pressure of the emitter (h_m) to the maximum one (h_M). The following relationship can be written:

$$\frac{h_m}{h_M} = \frac{K \cdot Q_m^2}{K \cdot Q_M^2} = r_h \quad (18)$$

Applying the affinity laws, the following set of relationships can be derived:

$$\left. \begin{aligned} \frac{N_m}{N_M} &= \frac{Q_m}{Q_M} = \sqrt{r_h} \\ \frac{H_m}{H_M} &= \frac{Q_m^2}{Q_M^2} = r_h \\ \frac{P_m}{P_M} &= \left(\frac{H_m}{H_M} \right)^{3/2} = r_h^{3/2} \end{aligned} \right\} \quad (19)$$

where: subscript m refers to the minimum operational values of each variable and subscript M refers to the operational conditions for the pump operating at its maximum speed

For a unique irrigation sector per hectare, the power transmitted to the pump is equal to the net power produced by the PV system ($P = P_i$) and the response of the pumping system can be modelled by the following set of equations:

$$\left. \begin{aligned} a) \text{ IF } P < P_m = \frac{P_M}{r_h^{3/2}} &\Rightarrow Q_i = 0 \\ b) \text{ IF } P_m \leq P \leq P_M &\Rightarrow Q_i = Q_M \left(\frac{P_i}{P_M} \right)^{1/3} \\ c) \text{ IF } P > P_M &\Rightarrow Q_i = Q_M \end{aligned} \right\} \quad (20)$$

However, in order to optimize the use of the generated energy for irrigating the crops, more than one irrigation sector per hectare is going to be considered. The proposed model divides every hectare of farm in a number of sectors (n_s) ranging from 1 to 6. When the hectare is subdivided into more than one sector, the discharge and power needed to irrigate each sector can be obtained by dividing the maximum discharge and the maximum power by the total number of sectors.

If only one out of the n_s sectors is in operation, the power generated by the PV systems is entirely transferred to the only pump in operation ($P = P_i$) and the discharge of the pump is thus given by the following equation.

$$\left. \begin{aligned} a) \text{ IF } P < \frac{P_m}{n_s} &\Rightarrow Q_i = 0 \\ b) \text{ IF } \frac{P_m}{n_s} \leq P \leq \frac{P_M}{n_s} &\Rightarrow Q_i = \frac{Q_M}{n_s} \left(\frac{P_i \cdot n_s}{P_M} \right)^{1/3} \\ c) \text{ IF } P > \frac{P_M}{n_s} &\Rightarrow Q_i = \frac{Q_M}{n_s} \end{aligned} \right\} \quad (21)$$

And generalizing, when a number “ n_j ” of sectors out of n_s are operating simultaneously, the net power generated by the PV system (P) has to be distributed among the n_j pumps in operation ($P_i = P/n_j$) and the total discharge of the system is thus given by the set of Equation (22):

$$\left. \begin{aligned} a) \text{ IF } \frac{P}{n_j} < \frac{P_m}{n_s} &\Rightarrow Q_i = 0 \\ b) \text{ IF } \frac{P_m}{n_s} \leq \frac{P}{n_j} \leq \frac{P_M}{n_s} &\Rightarrow Q_i = n_j \frac{Q_M}{n_s} \left(\frac{P_i}{n_j} \frac{n_s}{P_M} \right)^{1/3} \\ c) \text{ IF } \frac{P}{n_j} > \frac{P_M}{n_s} &\Rightarrow Q_i = \frac{Q_M}{n_s} \cdot n_j \end{aligned} \right\} \quad (22)$$

For the sake of illustration, Fig. 3 depicts the discharge of the pumping system as a function of the incoming power for an irrigation system composed of a total of 4 sectors per hectare. In this example, a greenhouse farm of 1 ha with emitters of a discharge equal to 3 L h⁻¹ and 2 emitters m⁻² (1 m × 0.5 m) has been considered, which is a very common arrangement in greenhouse irrigation systems in south of Spain. This results in a total discharge per hectare (Q_M) equal to 60000 L h⁻¹ or 16.67 L s⁻¹. The total head (H_M) assumed for this maximum discharge is 40 m (including the three terms in Equation (8)). The pumping efficiency has been considered equal to 0.75. The maximum power (P_M) per hectare results equal to 8720 W. The ratio between minimum and maximum working pressure of the emitter has been supposed equal to 1/4 (5/20 m/m). Applying affinity laws in Equation (19), the minimum power required per hectare (P_m) results equal to one

eighth of the maximum power ($P_M/8$). With these data, and applying the set of Equation (22), the discharge has been calculated for a number of sectors in operation ranging from 1 to 4.

Dashed lines represent the variation of the discharge of the system as a function of the incoming power when only one, two, three or all four sectors are in operation. Continuous lines indicate the operational strategy in order to maximize the discharge of the system for every generated power value.

The proposed model allows analyzing two different management strategies:

1. Only one sector in operation. This strategy implies that only one sector can be operated simultaneously. The advantage of this strategy is that only one pump is required thus minimizing the pumping system installation costs. The drawback is that the discharge of the system as a function of the incoming power is lower than in strategy 2 (red line in Fig. 3).
2. Maximizing the discharge as a function of the power generated. In this operational strategy, the aim is to maximize the total discharge of the system as a function of the incoming power provided by the PV system. The model calculates the discharge (Q_i), as a function of the incoming power from the PV system (P_i), for a total number of sectors in operation (n_j) from 1 to n_s and puts into operation simultaneously the number of sectors that provides the maximum discharge (as depicted in Fig. 3). The drawback of this strategy is that one pump per sector in operation is required and the cost of the pumping system is thus higher.

2.5. Water balance equation

The water content in the soil-crop system can be estimated by applying a water balance on a daily basis. The input of water to the soil in a protected cultivation is exclusively the net water irrigation depth applied (R_n). R_n is calculated by multiplying the gross water irrigation depth applied by the irrigation efficiency. The output of water from the system is the average irrigation water requirement (IR_i). The conservation of mass principle states that the difference between the inputs of water to the system and the outputs of water from the system must be equal to the variation of the water stored in the soil, resulting in the following equation:

$$D_d = D_{d-1} + IR_d - R_{n,d} \tag{23}$$

where: D_d, D_{d-1} is the water depletion in the soil for the actual day (d) and previous day ($d - 1$), respectively. The water depletion is defined as the depth of water depleted from the soil.

The soil in the root zone has an upper as well as a lower limit of storing water that can be used by crops. The upper limit is called the field capacity (FC), which is the amount of water that can be held by the soil against gravity after being saturated and drained. The lower limit is called permanent wilting point (PWP), which is the amount of water remaining in the soil when the plant permanently wilts because it can no longer extract water. The available water capacity (AWC), or total available water, of the soil is the amount of water stored in the soil between these two limits. However, in irrigation practice, only a percentage of AWC is allowed to be depleted because plants start to experience water stress. This percentage is termed management allowed depletion (MAD).

2.6. Economic feasibility analysis

In this work, the economic feasibility of installing the proposed PV direct pumping irrigation system instead of a conventional grid-fed irrigation system is evaluated.

The objective is to fully satisfy the calculated requirements as under irrigation in greenhouse culture is not recommendable due to the high susceptibility of the crops to water stress and the high yield and economic losses.

The economic returns obtained from the crop yield are the same independently of the type of irrigation system used. Consequently, to evaluate the profitability of a PV system, the benefits of using PV energy is the cost of the electric energy saved. A price of 0.1597 €/kWh has been considered for the electric energy provided by the grid.

The increment in investment costs for the PV system is due to the additional pumps required and the cost of the PV system itself. A cost of 2 € per Watt-Peak has been considered for the PV array (including inverter and accessories). To calculate the cost of the pumps the regression function depicted in Fig. 4 has been used. This regression has been calculated as a function of the cost of different units of a variable speed pump series [20].

The assessment of the economic feasibility of the irrigation

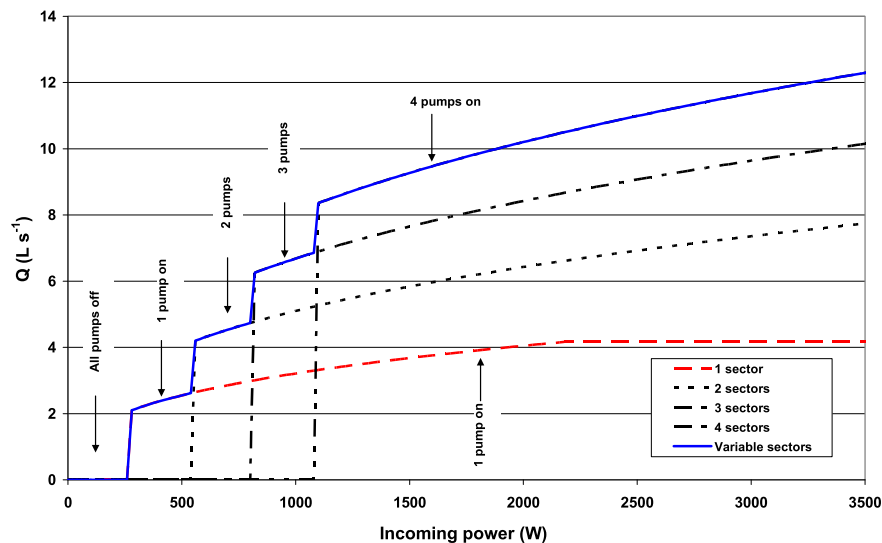

Fig. 3. Discharge-power diagram for a PV irrigation system composed of a total of 4 sectors per hectare.

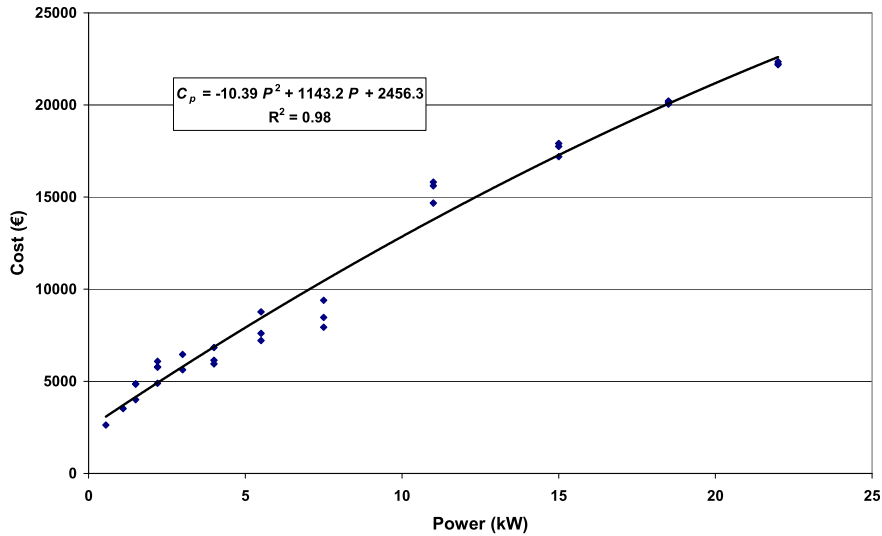

Fig. 4. Cost of the pumps.

conversion is going to be made by calculating the Net Present Value (NPV) with a useful life of the project of 25 years. The discount rate is supposed to be equal to 3% and an annual increment in the price of the energy of 5% has been considered. This increment seems to be reasonable as the annual increment of the price of the energy in Spain in the last decade has been close to 10%.

3. Results

Fig. 5 shows the evolution of the calculated irrigation water requirements (ET_c) expressed in mm day^{-1} for the average representative greenhouse and the incoming solar radiation (R_s). Radiation is expressed as equivalent evaporation and its unit is also (mm day^{-1}) . Radiation expressed in $\text{MJ m}^{-2} \text{day}^{-1}$ can be converted to equivalent evaporation by using a conversion factor equal to the inverse of the latent heat of vaporization ($1/\lambda = 0.408$).

Two peak periods can be distinguished. The maximum irrigation requirements occur in May, at the end of the spring crop cycles. There is another local maximum in the irrigation requirements at

the beginning of October coinciding with the development of the autumn cycle crops. During summer months, water consumption for irrigation is very low as there are no crops during that period. This is because spring cycle crops have already been harvested and the autumn cycle crops are not planted yet. Fig. 4 illustrates that, the trend in the water consumption of greenhouse crops does not coincide with the trend of the incoming radiation.

The model simulates the performance of the system for increasing peak power values starting from zero and with increments of 50 W. For every peak power value, the net power produced by the photovoltaic system, the model calculates the total energy used and lost by the irrigation system, the irrigation water applied, the irrigation water deficit and finally the net present value.

The results found for the first scenario with only one sector in operation are discussed hereinafter:

Fig. 6 shows the sizing of the PV provided by the model needed to fully satisfy the irrigation requirements as a function of the number of sectors per hectare.

The peak power required to fully irrigate the crops decreases for

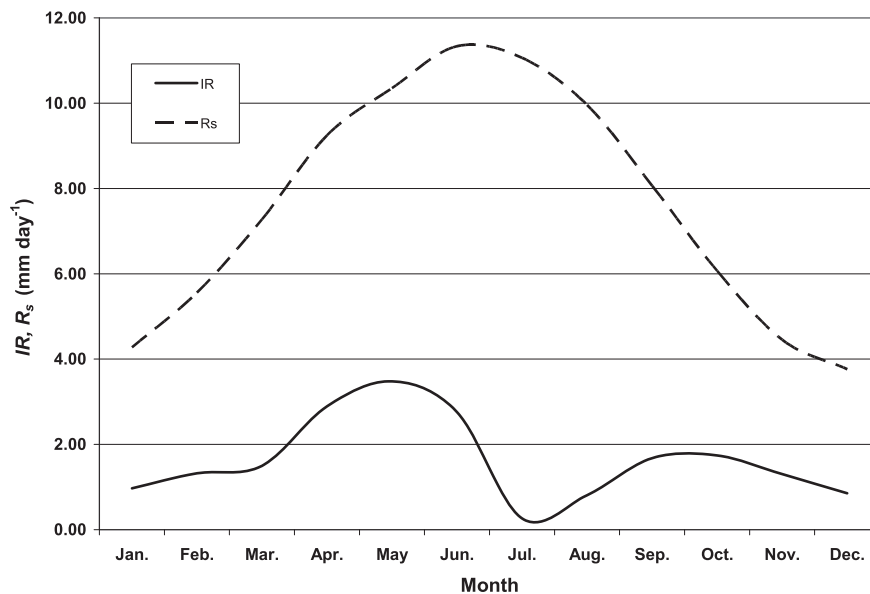

Fig. 5. Average irrigation requirements (IR) and incoming solar radiation (R_s).

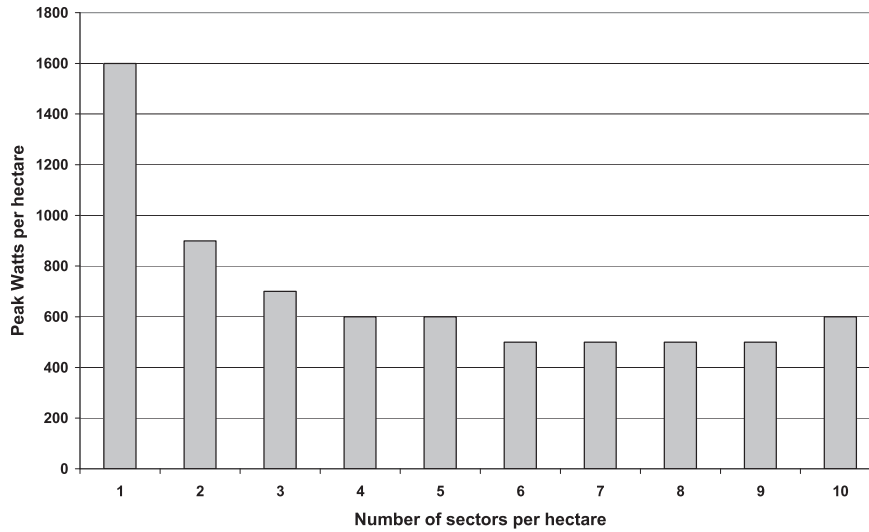

Fig. 6. Peak power values provided by the model that satisfy the irrigation needs.

increasing number of sectors. To irrigate 1 ha of greenhouse with only one sector requires a PV array of 1600 Peak Watts while subdividing the hectare in smaller sectors considerably reduces the required Peak-Power. The lowest value of Peak-Watts is achieved with 6 sectors per hectare. Using more than 6 sectors does not further reduce the required Peak-Power and for a larger number of sectors it even increases. This is due to the fact that there is not enough time to irrigate the complete hectare with such a great number of sectors unless the irrigation time per sector diminishes and this can be only achieved by increasing the Peak-Watts of the PV system.

Fig. 7 shows the evolution of the irrigation deficits as a function of the PV Peak power for every number of irrigation sectors.

It is interesting to evaluate the performance of the system not only from a technical or economic standpoint but also from an environmental perspective. In order to assess the actual use of the energy produced by the system, an energy use efficiency ratio has been calculated. An efficiency index is broadly defined as the ratio

of the output of a process to its input. In this case, the energy use efficiency index is defined as the ratio of the energy that is effectively used to irrigate the crops to the total energy produced by the PV system. In this work, the energy produced by the PV system that is not used to irrigate is considered as an energy loss.

Fig. 8 shows the evolution of the energy use efficiency as a function of the peak power of the PV system for every value of the pumping head.

The results provided by the model show that the effective use of the energy produced is not high. Maximum energy use efficiency was obtained for 6 irrigation sectors. The maximum value was slightly higher than 40%, but it was achieved for a Peak Power lower than that required for a full irrigation of the greenhouse. In the case of a full irrigation the energy use efficiency was 35%. The energy use efficiency ratios were lower for lower number of irrigation sectors. These energy use ratios could be improved if the energy surplus produced by the PV system were used for other purposes. For example, in high technology greenhouses, the excess of energy in

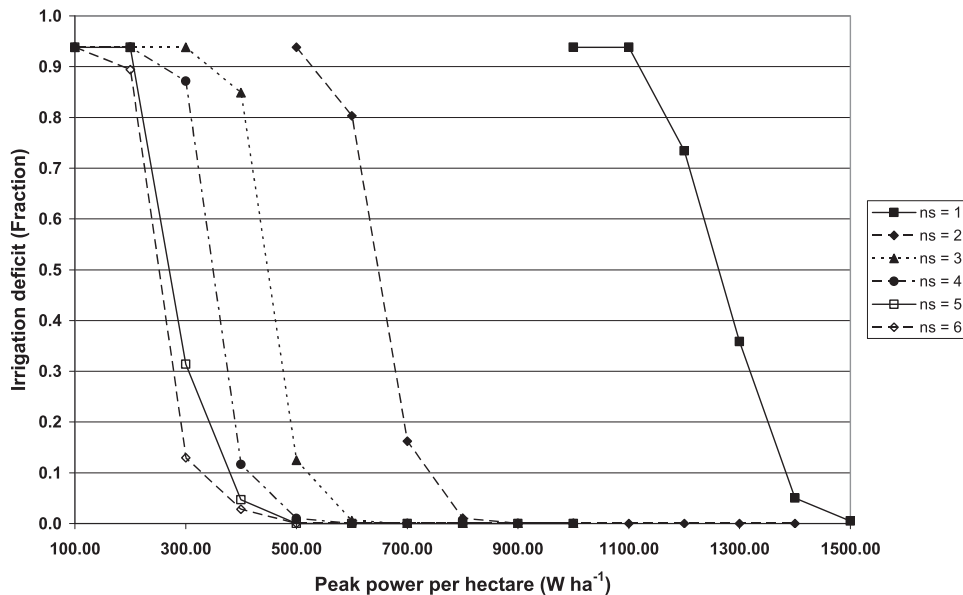

Fig. 7. Evolution of the relative irrigation deficits as a function of the PV Peak power for every number of irrigation sectors.

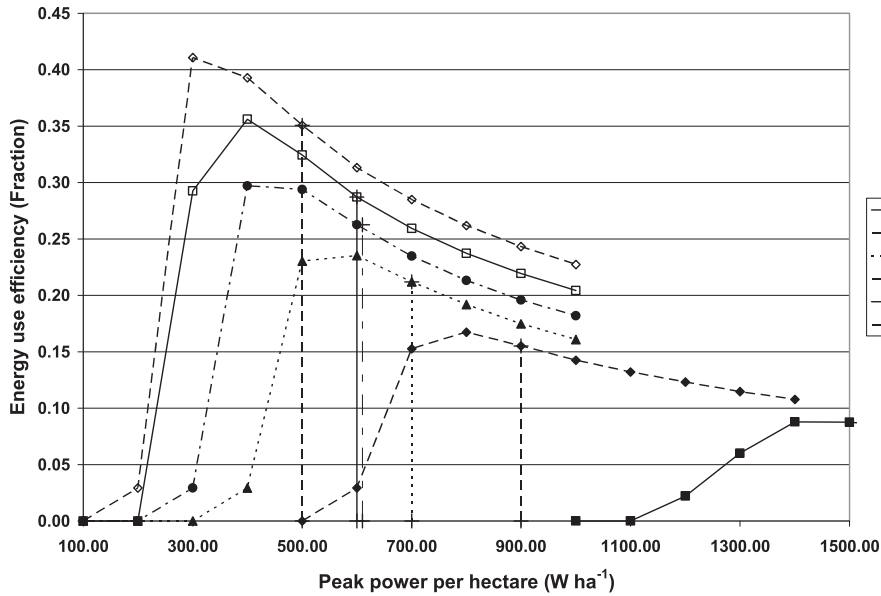

Fig. 8. Evolution of the energy use efficiency as a function of the PV Peak power for every number of irrigation sectors.

summer could be used to refrigerate the greenhouse with no additional cost.

Fig. 9 shows the evolution of the Net Present Value (NPV) as a function of the PV Peak power for every number of sectors. The profitability of using a PV system to irrigate greenhouse crops is not very high. In fact, NPV values were negative for a number of irrigation sectors lower than 4. Positive NPV were found for irrigation sector greater or equal to 4. Maximum NPV values were found for designs that produced a slight under irrigation for the crops. However, NPV values for full irrigation were relatively close to those maximum values: 1450, 1000 and 900 €/ha for 6, 5 and 4 sectors per hectare, respectively.

Table 3 shows the results of the comparison between both simulation scenarios considered: with only one sector in operation and with a variable number of sectors working simultaneously as a function of the generated power. The minimum Peak-Power values

required to fully satisfy the irrigation needs are presented in this table along with the resulting values of the energy use efficiency (EUE) and net present value (NPV) for this optimal Peak-Power. The maximum number of sectors simultaneously in operation (n_j) and the operating time (in hours) with a number of pumps working simultaneously ranging from 1 to n_j are also included in the table.

Results show that the optimal policy is to operate with only one irrigation sector instead of more than one working simultaneously. In fact, for a total number of sectors per hectare ranging from 1 to 3, both strategies provided the same results as the optimal solution was to keep only one sector in operation (see Table 3). When the total number of sectors is between 3 and 6, a second sector was put into operation in the variable sectors strategy. However, the working times of this second sector in operation were relatively short (see Table 3) as it was put into operation only during very high radiation periods.

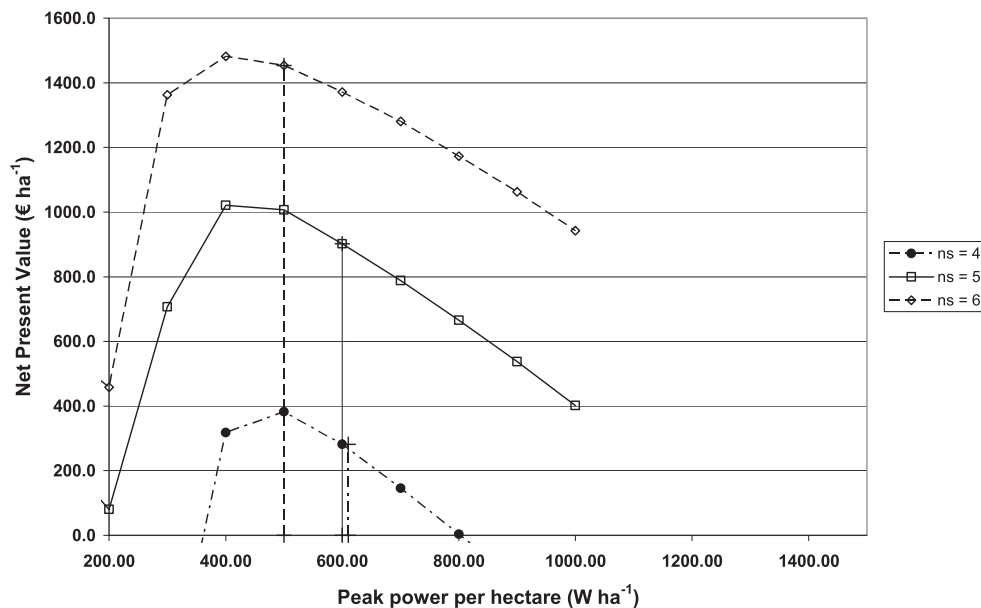

Fig. 9. Evolution of the Net Present Value as a function of the PV Peak-Power for different number of irrigation sectors.

Table 3

Minimum peak-power, energy use efficiency and net present values for the two simulation scenarios: only one sector and variable number of sectors in operation.

n_s	Strategy 1 (only 1 sector in operation)					Strategy 2 (Variable sectors)					
	n_j	t_1 (h)	Opt. PP (W ha ⁻¹)	EUE	NPV (€ ha ⁻¹)	n_j	t_1 (h)	t_2 (h)	Opt. PP (W ha ⁻¹)	EUE	NPV (€ ha ⁻¹)
1	1	204	1600	0.08	-8686	1	204	0	1600	0.08	-8686
2	1	398	900	0.16	-2831	1	398	0	900	0.16	-2831
3	1	580	700	0.21	-797	1	580	0	700	0.21	-797
4	1	751	600	0.26	282	2	743	5	600	0.26	-4626
5	1	901	600	0.29	902	2	716	117	600	0.26	-3680
6	1	1071	500	0.35	1453	2	793	175	500	0.31	-2845

n_s = Total number of sectors per hectare.

n_j = Maximum number of sector simultaneously in operation.

t_i = Working time in hours with “i” pumps working simultaneously.

Opt. PP = Optimal peak-power value for n_s sectors.

EUE = Energy use efficiency n_s sectors.

NPV = Net present value for n_s sectors.

NPV values higher than zero are written in bold.

Peak-Power values were the same in both cases, so the cost of the PV system was identical but the investment costs in the second strategy was penalized by the higher cost of the two pumps that are necessary in this second case. As a consequence, NPV values were higher in the first case due to the lower cost of the pumping system. Putting more than two sectors operating simultaneously was not necessary in any case according to the simulation model for a total number of sectors less than or equal to 6 per hectare.

Resulting NPV values were positive only for one sector in operation and for more than 4 sectors per hectare. This fact indicates that the system is profitable only in these particular cases. NPV values were always negative in the case of multiple sectors in operation.

There were no relevant differences in the energy use efficiency values between both scenarios, although slightly higher values were found for the first one.

The developed model demonstrated that the use of stand-alone direct pumping irrigation systems can be a profitable alternative to irrigate greenhouse crops if irrigation systems are designed with at least 4 sectors per hectare and these sectors irrigate sequentially. This model is a useful tool for the optimal design of this type of irrigation system and allows analyzing its feasibility for different crops and climate conditions.

4. Conclusions

It has been proved that stand-alone direct pumping irrigation systems can be a technical and economically feasible alternative to irrigate greenhouse crops provided that the irrigation farms are subdivided into an appropriate number of sectors per hectare.

The profitability and energy use efficiency of these systems are limited. However, these variables could be improved if the excess of energy produced by the PV system and not used for irrigation were used for other purposes, such as ventilating or cooling the greenhouse.

The model has demonstrated that the optimal operation strategy is to irrigate with only one sector in operation. The system is economically profitable for at least 4 sectors per hectare.

The developed model is a useful tool for the optimal design of stand-alone direct PV irrigation systems for greenhouse crops.

The proposed system can be successfully implemented to irrigate greenhouse crops, not only in developed countries where a wide electricity grid is available, but it is also even more interesting in developing countries where there are less electricity facilities available.

Acknowledgements

The authors acknowledge the support of the Spanish Ministry for Science and Innovation under the contract CGL2010-21865.

Notation

CA	total area of a crop (ha)
D	soil water depletion
GA	total greenhouse area (ha)
H	total energy head (m)
h	working pressure head at the emitter (m)
hf	overall head loss in the distribution network (m)
I(t)	irradiance on the inclined collector plane (W m ⁻²)
I _b (t)	solar direct irradiance as a function of time t (W m ⁻²)
I _d (t)	solar diffuse irradiance as a function of time t (W m ⁻²)
IR	irrigation requirements
I _m	irradiance minimum threshold value (W m ⁻²)
I _{STC}	irradiance under standard conditions (W m ⁻²)
k	discharge coefficient of the emitter
K	overall inverse discharge coefficient of the emitters in the irrigation network
N	pump speed (rpm)
n _c	total number of crops
n _e	Total number of emitters in the irrigation system
n _j	number of irrigation sectors in operation
n _s	total number of irrigation sectors per hectare
P	net power transferred to the water (W)
PP	peak power generated by the PV modules under standard conditions (W)
P _{PV}	photovoltaic power provided by the PV system (W)
P _{PV,min}	minimum value of utilizable photovoltaic power (W)
q	emitter discharge
Q	total discharge of the pumping system (m ³ /s)
r _h	ratio of the minimum working pressure of the emitter (h _m) to the maximum (h _M)
R _n	net irrigation depth (mm)
R _s	equivalent resistance coefficient of the irrigation network
S	slope coefficient for silicon cells °C/(W m ⁻²)
T _a	air temperature (°C)
T _{cell}	temperature of the cells in the module (°C)
T _{STC}	cell temperature under standard test conditions (°C)
x	pressure-discharge exponent of the emitter
β	performance decay coefficient due to the rising temperature of the cell
Δz	elevation change (m)
η _{FC}	converter efficiency

η_{AM}	asynchronous motor efficiency
η_P	pump efficiency
φ	tilt angle of the PV modules
ρ	Albedo
θ	direct solar radiation incidence angle with respect to the inclined collector plane
θ_z	direct solar radiation incidence angle with respect to the horizontal plane

Subscripts

c	refers to a specific crop c
d	refers to a specific day d
i	refers to the working conditions for the pump operating at any intermediate speed
M	refers to the working conditions for the pump operating at its maximum speed
m	refers to the working conditions for the pump operating at its lowest speed
w	refers to a specific week w

References

- [1] A.M. Abdel-Ghany, I.M. y Al-Helal, Solar energy utilization by a greenhouse: general relations, *Renew. Energy* 36 (1) (2011) 189–196.
- [2] A.R. Al-Ali, S. Rehman, S. Al-Agili, M.H. Al-Omari, M. Al-Fayez, Usage of photovoltaics in an automated irrigation system, *Renew. Energy* 23 (2001) 17–26, [http://dx.doi.org/10.1016/S0960-1481\(00\)00110-5](http://dx.doi.org/10.1016/S0960-1481(00)00110-5).
- [3] M. Alonso Abella, E. Lorenzo, F. Chenlo, PV water pumping systems based on standard frequency converters, *Prog. Photovolt. Res. Appl.* 11 (2003) 179–191, <http://dx.doi.org/10.1002/ppp.475>.
- [4] E.H. Amer, M.A. Younes, Estimating the monthly discharge of a photovoltaic water pumping system: model verification, *Energy Convers. Manage.* 47 (15–16) (2006) 2092–2102.
- [5] A. Baille, C. Kittas, N. Katsoulas, Influence of whitening on greenhouse microclimate and crop energy partitioning, *Agric. For. Meteorol.* 107 (4) (2001) 293–306.
- [6] A. Betka, A. Attali, Optimization of a photovoltaic pumping system based on the optimal control theory, *Sol. Energy* 84 (2010) 1273–1283.
- [7] A. Betka, A. Moussi, Performance optimization of a photovoltaic induction motor pumping system, *Renew. Energy* 29 (2004) 2167–2181.
- [8] P.R. Bhave, *Analysis of Flow in Water Distribution Networks*, Technomic Pub. Co, 1991.
- [9] M. Biancardo, K. Taira, N. Kogo, H. Kikuchi, N. Kumagai, N. Kuratani, I. Inagawa, S. Imoto, J. Nakata, Characterization of microspherical semi-transparent solar cells and modules, *Sol. Energy* 81 (2007) 711–716, <http://dx.doi.org/10.1016/j.solener.2006.10.009>.
- [10] B. Bouzidi, New sizing method of PV water pumping systems, *Sustain. Energy Technol. Assess.* 4 (2013) 1–10.
- [11] D. Briassoulis, D. Waaijenberg, J. Grattraud, B. von Elsner, Mechanical properties of covering materials for greenhouses: part I. General overview, *J. Agric. Eng. Res.* 67 (3) (1997) 81–96, <http://dx.doi.org/10.1006/jaer.1997.0155>.
- [12] A.J. Callejón-Ferre, F. Manzano-Agugliaro, M. Díaz-Pérez, A. Carreño-Ortega, J. Pérez-Alonso, Effect of shading with aluminized screens on fruit production and quality in tomato (*Solanum lycopersicum* L.) under greenhouse conditions, *Span. J. Agric. Res.* 7 (1) (2009) 41–49.
- [13] J. Carroquino, R. Dufo-López, J.L. Bernal-Agustín, Sizing of off-grid renewable energy systems for drip irrigation in Mediterranean crops, *Renew. Energy* 76 (2015) 566–574, <http://dx.doi.org/10.1016/j.renene.2014.11.069>.
- [14] L. Castaner, S. Bermejo, T. Markvart, K. Fragaki, in: T. Markvart, L. Castaner (Eds.), *Practical Handbook of Photovoltaic Fundamentals and Applications*, Elsevier, UK, 2003.
- [15] A.J. Céspedes, M.C. García, J.J. Pérez-Parra, I.M. Cuadrado, Caracterización de la explotación horticola protegida almeriense, Fundación para la investigación agraria en la provincia de Almería (FIAPA), Almería (Spain), 2010.
- [16] M. Collares-Pereira, A. Rabl, The average distribution of solar radiation-correlations between diffuse and hemispherical and between daily and hourly insolation values, *Sol. Energy* 22 (2) (1979) 155–164.
- [17] J.A. Duffie, W.A. Beckman, *Solar Engineering of Thermal Process*, third ed., John Wiley & Sons, Wiley, 2006.
- [18] Eurostat, Energy, Transport and Environment Indicators, Publications Office of the European Union, Luxembourg, 2013, <http://dx.doi.org/10.2785/4663>, 2013. ISBN 978-92-79-33105-3. ISSN 1725-4566.
- [19] M.D. Fernández, A.M. González, J. Carreño, C. Pérez, S. Bonachela, Analysis of on-farm irrigation performance in Mediterranean greenhouses, *Agric. Water Manage.* 89 (2007) 251–260, <http://dx.doi.org/10.1016/j.agwat.2007.02.001>.
- [20] S.A. Grundfos España, Tarifa de precios 2014, 2014. Madrid (Spain), www.grundfos.es.
- [21] A. Hamidat, B. Benyoucef, T. Hartani, Small-scale irrigation with photovoltaic water pumping system in Sahara regions, *Renew. Energy* 28 (2003) 1081–1096.
- [22] A. Hamidat, B. Benyoucef, Systematic procedures for sizing photovoltaic pumping system, using water tank storage, *Energy Policy* 37 (2009) 1489–1501, <http://dx.doi.org/10.1016/j.enpol.2008.12.014>.
- [23] M. Kadowaki, A. Yano, F. Ishizu, T. Tanaka, S. Noda, Effects of greenhouse photovoltaic array shading on Welsh onion growth, *Biosyst. Eng.* 111 (2012) 290–297.
- [24] J. Keller, R.D. Bliesner, *Sprinkle and Trickle Irrigation*, in: *An Avi Book Series*, Van Nostrand Reinhold, 1990.
- [25] E. Kitta, A.D. Baille, N. Katsoulas, N. Rigakis, M.M. González-Real, Effects of cover optical properties on screenhouse radiative environment and sweet pepper productivity, *Biosyst. Eng.* 122 (2014) 115–126, <http://dx.doi.org/10.1016/j.biosystemseng.2014.04.001>.
- [26] C. Kittas, N. Katsoulas, A. Baille, Influence of aluminized thermal screens on greenhouse microclimate and night transpiration, *Acta Hort.* (ISHS) 614 (2003) 387–392, http://www.actahort.org/books/614/614_58.htm.
- [27] J.C. López, A. Baille, S. Bonachela, J. Pérez-Parra, Analysis and prediction of greenhouse green bean (*Phaseolus vulgaris* L.) production in a Mediterranean climate, *Biosyst. Eng.* 100 (2008) 86–95, <http://dx.doi.org/10.1016/j.biosystemseng.2008.02.006>.
- [28] R. López-Luque, J. Reca, J. Martínez, Optimal design of a standalone direct pumping photovoltaic system for deficit irrigation of olive orchards, *Appl. Energy* 149 (2015) 13–23, <http://dx.doi.org/10.1016/j.apenergy.2015.03.107>.
- [29] J. López-Marín, A. Gálvez, A. González, C. Egea-Gilabert, J.A. Fernández, Effect of shade on yield, quality and photosynthesis-related parameters of sweet pepper plants, *Acta Hort.* (ISHS) 956 (2012) 545–552.
- [30] K. Meah, S. Ula, S. Barrett, Solar photovoltaic water pumping—opportunities and challenges, *Renew. Sustain. Energy Rev.* 12 (2008) 1162–1175, <http://dx.doi.org/10.1016/j.rser.2006.10.020>.
- [31] O. Ozgener, Use of solar assisted geothermal heat pump and small wind turbine systems for heating agricultural and residential buildings, *Energy* 35 (2010) 262–268, <http://dx.doi.org/10.1016/j.energy.2009.09.018>.
- [32] O. Ozgener, A. Hepbasli, Experimental investigation of the performance of a solar-assisted ground-source heat pump system for greenhouse heating, *Int. J. Energy Res.* 29 (2005) 217–231, <http://dx.doi.org/10.1002/er.1049>.
- [33] P.C. Pande, A.K. Singh, S. Ansari, S.K. Vyas, B.K. Dave, Design development and testing of a solar PV pump based drip system for orchards, *Renew. Energy* 28 (2003) 385–396, [http://dx.doi.org/10.1016/S0960-1481\(02\)00037-X](http://dx.doi.org/10.1016/S0960-1481(02)00037-X).
- [34] A. Pardossi, F. Tognoni, L. Crocchi, *Mediterranean greenhouse technology*, *Chron. Hortic.* 44 (2) (2004) 28–34.
- [35] J. Pérez-Alonso, M. Pérez-García, M. Pasamontes-Romera, A.J. Callejón-Ferre, Performance analysis and neural modelling of a greenhouse integrated photovoltaic system, *Renew. Sustain. Energy Rev.* 16 (2012) 4675–4685, <http://dx.doi.org/10.1016/j.rser.2012.04.002>.
- [36] J.A. Sánchez, J. Reca, J. Martínez, Irrigation water management in a mediterranean greenhouse district: irrigation adequacy assessment, *Irrig. Drain.* 64 (2015) 299–313, <http://dx.doi.org/10.1002/ird.1908>.
- [37] J.F. Sanjuán, Detección de la superficie invernada en la provincia de Almería a través de imágenes Raster, FIAPA, Almería, Spain, 2007.
- [38] P.J. Sonneveld, G.L.A.M. Swinkels, J. Campen, B.A.J. van Tuijl, H.J.J. Janssen, G.P.A. Bot, Performance results of a solar greenhouse combining electrical and thermal energy production, *Biosyst. Eng.* 106 (1) (2010) 48e57.
- [39] P.J. Sonneveld, G.L.A.M. Swinkels, B.A.J. van Tuijl, H.J.J. Janssen, J. Campen, G.P.A. Bot, Performance of a concentrated photovoltaic energy system with static linear Fresnel lenses, *Sol. Energy* 85 (3) (2011) 432e442.
- [40] M. Torrellas, A. Antón, J.I. Montero, An environmental impact calculator for greenhouse production systems, *J. Environ. Manage.* 118 (2013) 186–195, <http://dx.doi.org/10.1016/j.jenvman.2013.01.011>.
- [41] R. Ureña-Sánchez, A.J. Callejón-Ferre, J. Pérez-Alonso, A. Carreño-Ortega, Greenhouse tomato production with electricity generation by roof-mounted flexible solar panels, *Sci. Agric.* 69 (4) (2012) 233e239.
- [42] D.L. Valera, L.J. Belmonte, F.D. Molina, A. López, in: *Los invernaderos de Almería. Análisis de su tecnología y rentabilidad*, 2014. Cajamar Caja Rural. Almería (Spain), www.publicacionescajamar.es.
- [43] O.C. Vilela, J. Bione, N. Fraidenraich, Simulation of grape culture irrigation with photovoltaic V-trough pumping systems, *Renew. Energy* 29 (2004) 1697–1705, <http://dx.doi.org/10.1016/j.renene.2004.02.002>.
- [44] A. Yano, A. Furue, M. Kadowaki, T. Tanaka, E. Hiraki, M. Miyamoto, F. Ishizu, S. Noda, Electrical energy generated by photovoltaic modules mounted inside the roof of a north–south oriented greenhouse, *Biosyst. Eng.* 103 (2009) 228–238, <http://dx.doi.org/10.1016/j.biosystemseng.2009.02.020>.
- [45] A. Yano, M. Kadowaki, A. Furue, N. Tamaki, T. Tanaka, E. Hiraki, Y. Kato, F. Ishizu, S. Noda, Shading and electrical features of a photovoltaic array mounted inside the roof of an east–west oriented greenhouse, *Biosyst. Eng.* 106 (2010) 367–377, <http://dx.doi.org/10.1016/j.biosystemseng.2010.04.007>.
- [46] A. Yano, M. Onoe, J. Nakata, Prototype semi-transparent photovoltaic modules for greenhouse roof applications, *Biosyst. Eng.* 122 (2014) 62–73, <http://dx.doi.org/10.1016/j.biosystemseng.2014.04.003>.
- [47] A. Yano, K. Tsuchiya, K. Nishi, T. Mori, O. Ide, Development of a greenhouse side-ventilation controller driven by photovoltaic energy, *Biosyst. Eng.* 96 (2007) 633–641, <http://dx.doi.org/10.1016/j.biosystemseng.2006.12.012>.